



Linear Single T8 Fixture





Products Specification

Ordering Information

Example: ICS-BR-LST8-4-15-120V-50K-FR

	2' length	3' length	4' length	4' length	5' length	6' length	8' length
	ICS-BR-LST8-2-9	ICS-BR-LST8-3-13	ICS-BR-LST8-4-18	ICS-BR-LST8-4-22	ICS-BR-LST8-5-20	ICS-BR-LST8-6-26	ICS-BR-LST8-8-120
LED Wattage	9W	13W	18W	22W	25W	28W	44W
Input Voltage	120-277VAC 50/60Hz						
Luminous Flux* (lm)	926	1,337	1,852	2,263	2,572	2,881	4,571
Luminous Flux** (lm)	882	1,274	1,764	2,156	2,450	2,744	4,269
Efficiency	130 lm/watt						
LED Type	Epistar (standard)						
Lens Material	Polycarbonate with 95% transmission						
IP Rating	IP 42						
CRI	≥82						
PF	>.98 @ 120VAC; >.94 @ 277VAC						
Certificates	CE, Rohs, ETL, DLC Premium						

Note: 8' (2400mm) - 200W/120VAC; 20W/277VAC

* Based on 5000K @ +/-10lm variance with clear lens

** Based on 5000K @ +/-10lm variance with frosted lens



Other option types and ordering details:

ORDERING DETAILS	OPTIONAL DESCRIPTIONS
120V, 277V, 347V	Voltage types: 120V, 100~277V, 120~347V
30K, 40K, 50K, 57K	3000-3500K, 4000-4500K, 5000-5500K, 5700-6000K
FR, CS	Lens: Frosted or Clear Striped

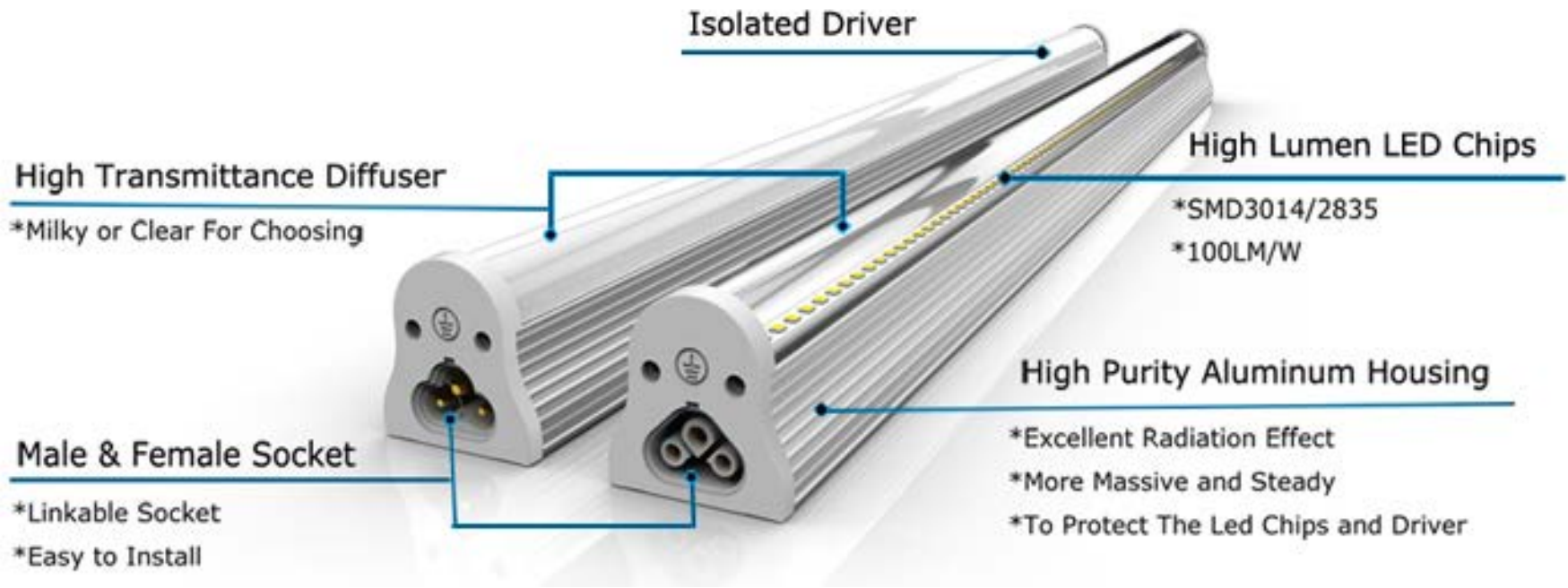





Photometric Pattern: Clear Lens

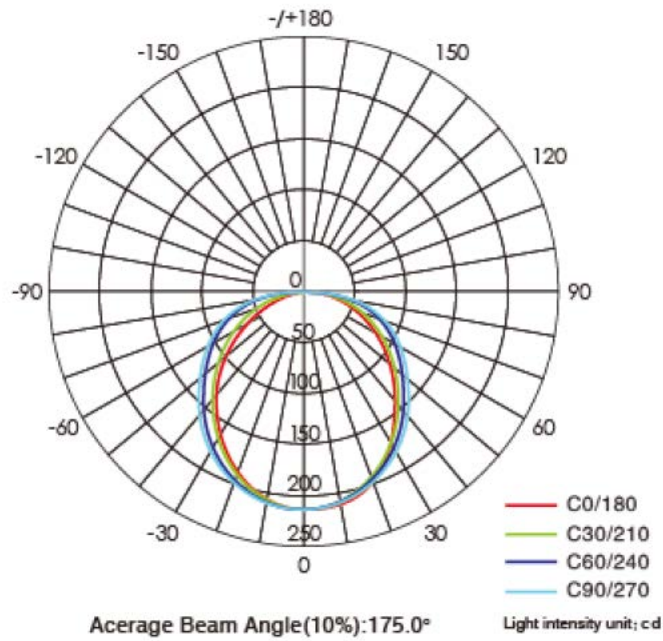



Design:

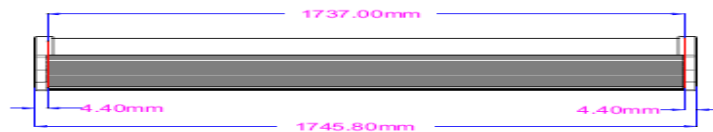
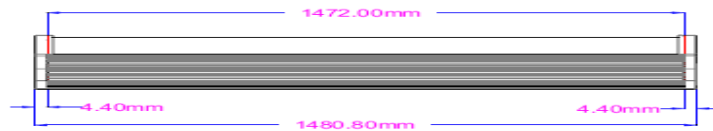
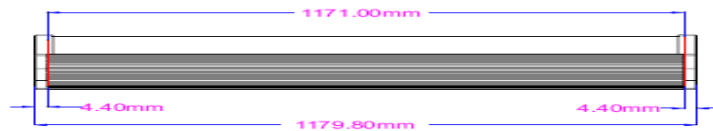
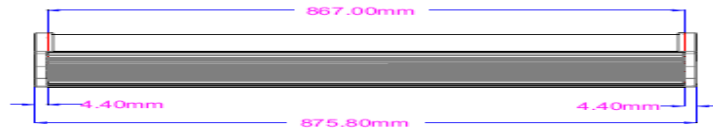
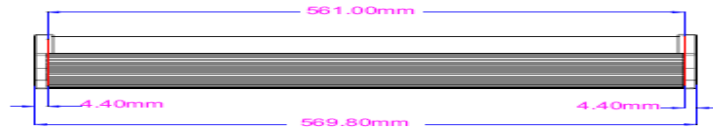



Connection Types:



Power cord
Power input



Linkable connector

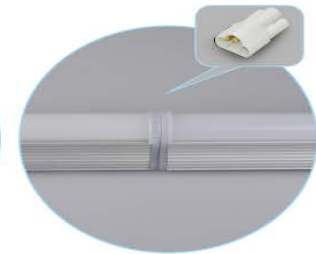

Small connector

Wire Details: White - N, Black - L, Yellow/Green - Ground

Designer Connectors (L Shape):





Mounting Options:

Flush Mount

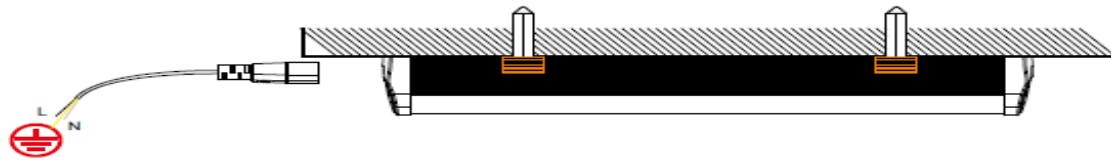

Connection Types:

In Series Connection

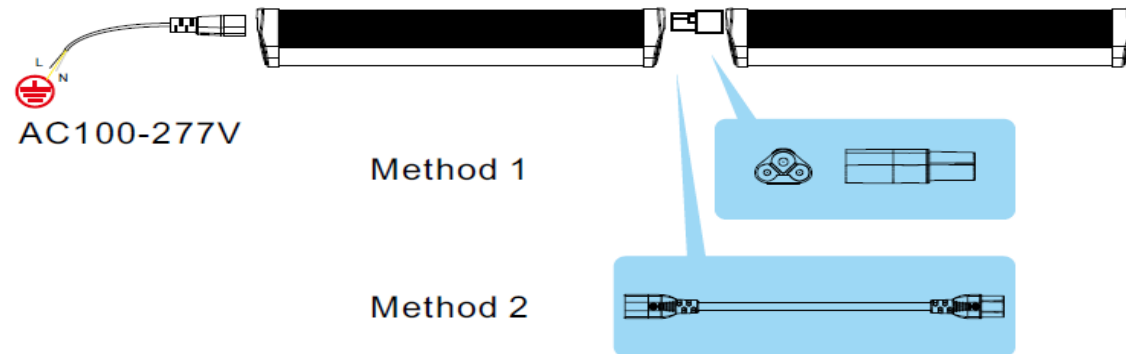



Max Connection: 200W

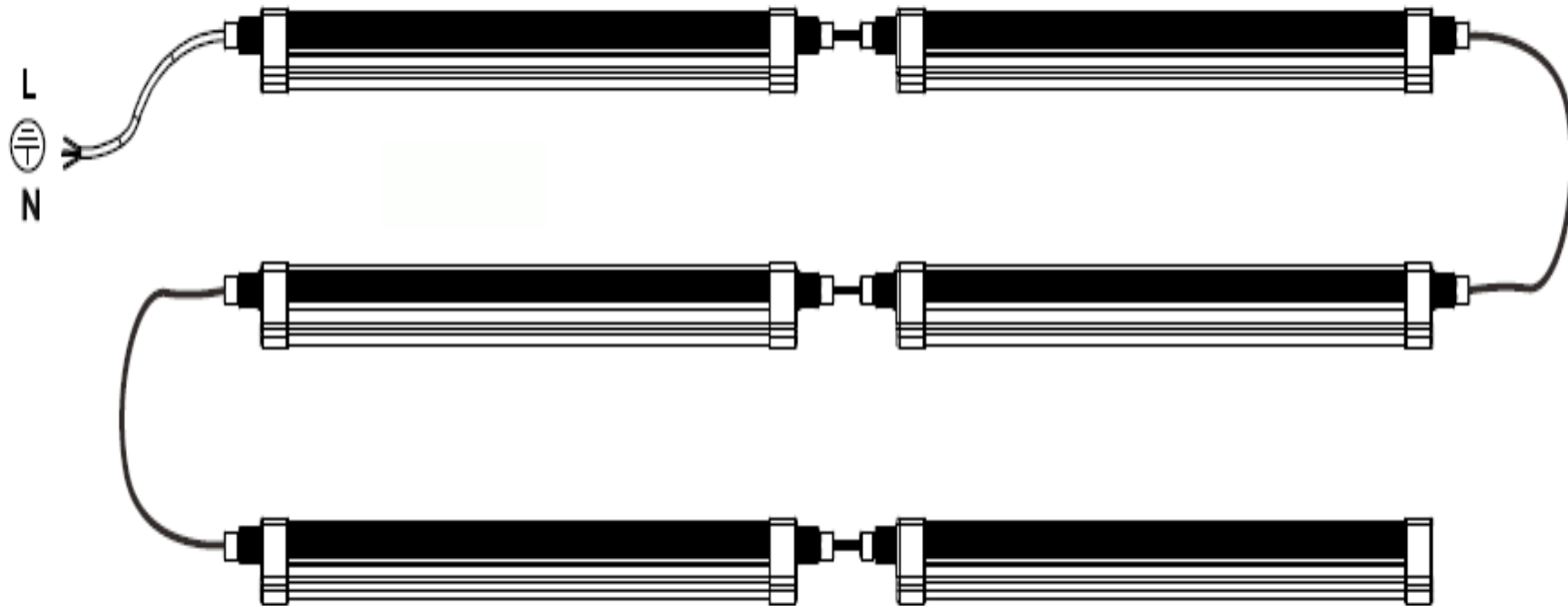



- ETL Listed
- DLC Listed
- 5 year warranty
- Easy and quick installation

Applications: Grocery Stores, Supermarkets, Gas Stations, Airports, Rail/Bus Stations, Parking Garages/Structures, Food & Drug processing Facilities, Commercial Freezers, Breweries, Industrial Warehouses, Factory Task Lighting, Car Washes

Products specifications, pictures, materials and details may change due to technology advancements. Bratic reserves the right to update any and all data without notification. Bratic T&C's of Sale apply.

